

Version 4.0



Table of Contents

Table of Contents	2
Preface.....	4
Chapter 1	5
Introduction to the Zpen.....	5
Digital Pen	6
Receiver	6
Zpen capabilities and features	7
System Requirements.....	8
Chapter 2	9
Operating the USB Flash Drive	9
Getting Started	10
Step 1: Familiarize Yourself with the Digital Pen	11
Replacing the ink refill	13
Inserting the pen's Batteries	14
Step 2: Familiarize Yourself with the Receiver	15
Step 3: Clip the Receiver to a Sheet of Paper	16
Step 4: Turn On the Receiver	16
Step 5: Begin Writing	17
Step 6: View Your Files on the Computer.....	19
Tips – Important Facts to Know	24

Chapter 3	26
Using the Multiplatform Viewer Application	26
Multiplatform Viewer Main Window	28
Menu Bar	29
Toolbars	32
Pages Pane	33
Writing Area	33
Navigating	37
Moving from Page to Page within a Document	37
Saving	39
Printing	40
Emailing	41
Set Clock	42
Select Receiver Position	43
Appendix A	44
FAQ	44
Appendix B	48
Troubleshooting guide.....	48
Appendix C	49
LED Functionality Index	49



Preface

Welcome to the Zpen User's Guide. This guide describes the operation and usage of the Zpen.

The guide includes the following chapters:

- **Chapter 1, Introduction to the Zpen,** introduces the Zpen, describing its basic features, components and system requirements
- **Chapter 2, Operating the Zpen,** provides a step by step guidance for operating and handling Zpen.
- **Chapter 3, Using the Multiplatform Viewer,** introduces the Multi Platform Viewer application and provides usage guidance.
- **Appendix A, FAQ,** presents a list of frequently asked questions and their respective detailed answers, related to the Zpen hardware and software.
- **Appendix B, Troubleshooting guide,** depicts a table with the recent product's known issues along with their workarounds and/or solutions related to the Zpen.
- **Appendix C, LED functionality index**



Chapter 1

Introduction to the Zpen

Overview

The Zpen provides all the benefits of a Digital Pen with the addition of full Flash memory capabilities. Completely portable, users can write, sketch and draw freely anywhere, using regular paper, while the device simultaneously captures and stores all written text and drawings in real-time to the Flash memory.

A multi-functional tool, stored data can be later uploaded to a PC via a standard USB port. Once uploaded, handwritten information can be transformed to digital text using standard handwriting recognition software, and notes as well as drawings can be edited and shared via email and messaging applications.

Small, compact and completely wireless, the Zpen can be used at home, school and at work. The perfect alternative to carrying a heavy laptop, it is ideal for taking notes and jotting down diagrams in both the meeting room and the classroom.

The product consists of two main hardware components – the Zpen and the Receiver.

Digital Pen

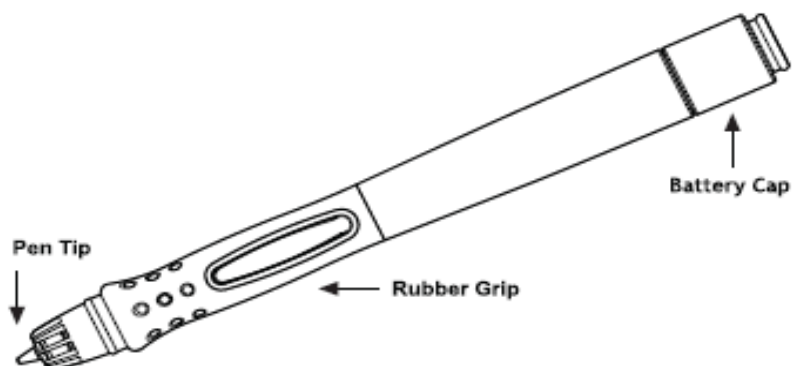

The pen constantly transmits its position to the receiver, whenever the pen tip is pressed.

The pen uses two standard 393 watch batteries and can fit any standard mini-ballpoint pen ink refill.

Receiver

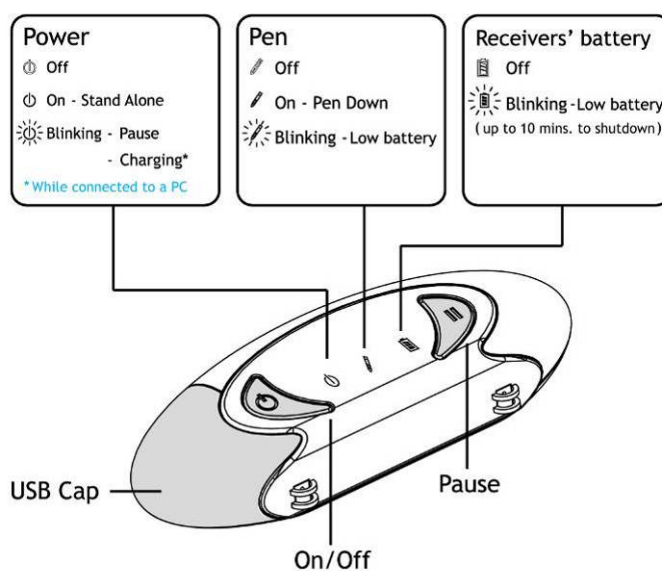

Information written or drawn using the pen is stored in the Receiver's flash memory, where it can later be retrieved via a standard USB connection. Written information can also be converted to text using standard handwriting recognition software.

The receiver captures the pen's position transmissions and stores them into files in the flash memory.

The receiver can be attached to any paper, with a coverage area up to an A4/letter page size and on any side of the paper.

The receiver can be easily connected to any PC via a standard USB connector. The Receiver contains a rechargeable battery, which gets automatically charged once being connected to a USB port.

!

IMPORTANT:

You MUST charge the Receiver for 6 hours before using it for the first time.

While charging, make sure the on/off led is blinking

Zpen capabilities and features

By using the Zpen you are able to:

- Write and sketch on any paper (up to size of A4/letter).
- Store thousands of pages of information on the flash memory.
- View, Edit and Organize digital captured pages using the Multi-platform Viewer and other applications
- Use the Receiver's USB flash memory as a standard flash drive to store music, images, video files, etc.
- Convert handwritten notes into computer text format

System Requirements

Before installing the Zpen Software, make sure your computer complies with the following system requirements:

- **Operating system:** Windows 2000, Windows XP, Windows Vista
- **Processor:** 1GHz processor and above
- Minimum **available hard disk space:** 200 MB
- **RAM:** 256 MB (recommended 512 MB)
- **USB connector:** available **standard** USB 1.1/2.0 port

Chapter 2

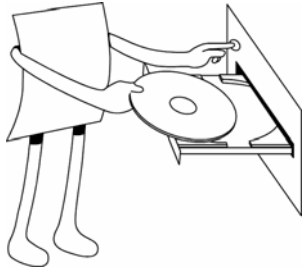

Operating the Zpen



About this chapter

This chapter describes how to get started and how to use the Zpen and USB Drive, as well as how to maintain it. It contains the following section:

The “Getting Started” section walks you through a typical example of how to handle and operate the Zpen.

Getting Started

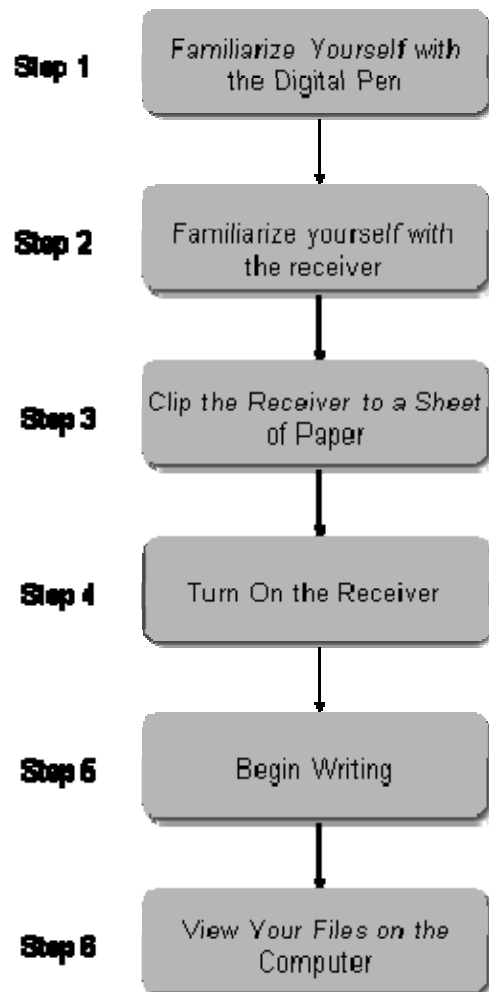

Step 1: Familiarize Yourself with the Digital Pen

The following picture depicts the Pen's various parts:

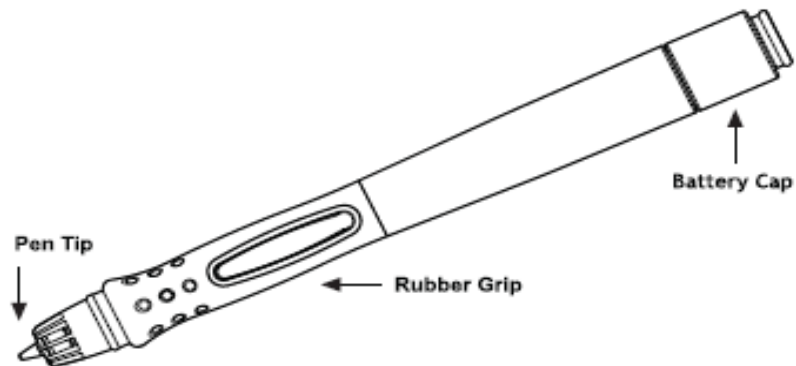

NOTES:

**Do not dismantle the Zpen in any way not described in this guide.
Improper use may damage the pen and cause it to cease functioning.**

The Zpen comes with two already inserted batteries. All you need to do is to remove the small isolator strip from the battery compartment (see picture below):

- Unscrew the top of the pen.
- Pull the isolator strip out
- Screw the Battery Cap back on

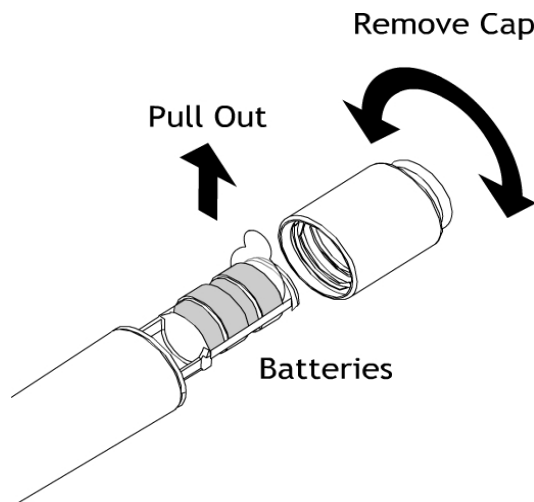

At some point, you may need to replace the Zpen's batteries or pen tip. The subsections that follow describe how to do so when necessary.

Replacing the ink refill

When replacement of the pen ink refill is needed, simply follow the drawing for extracting the ink refill (inserting a new standard mini-ballpoint ink refill is done in the same way).

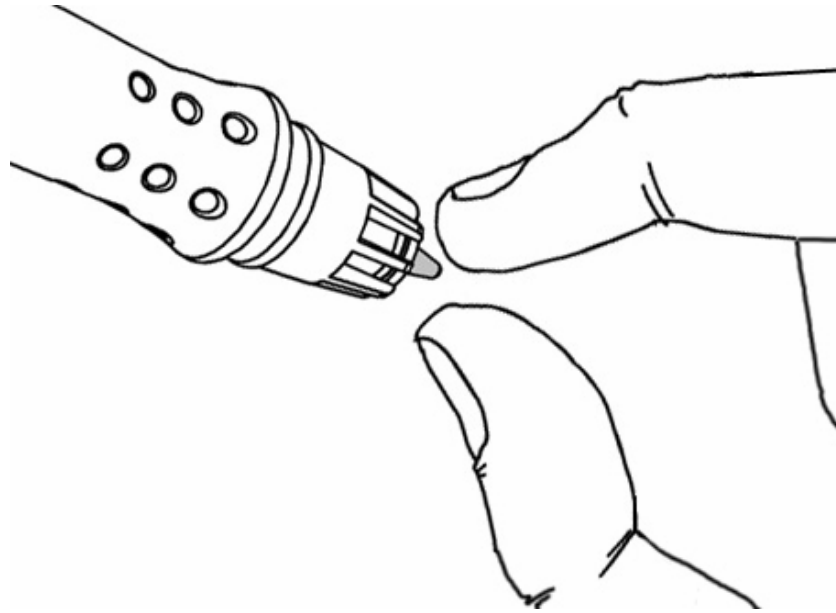

NOTES:

If the ink supply runs out, you can replace the pen tip with any standard mini-ballpoint writing tip.

Extra refills are optional and are not included with the pen by default. You can purchase them from the pen's vendor.

Inserting the pen's Batteries

The Zpen requires two regular 393 watch batteries.

To insert the Zpen batteries:

- 1 Unscrew the top of the pen.

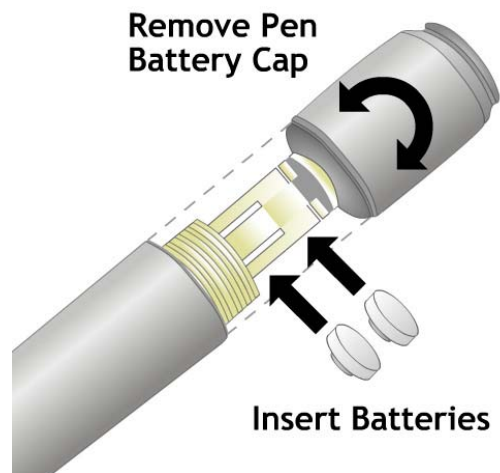

- 2 Insert the batteries.
- 3 Screw the pen top back on.

Step 2: Familiarize Yourself with the Receiver

The following drawing depicts the LEDs and buttons of the Receiver. For a detailed LED functionality index, refer to Appendix C in the user guide

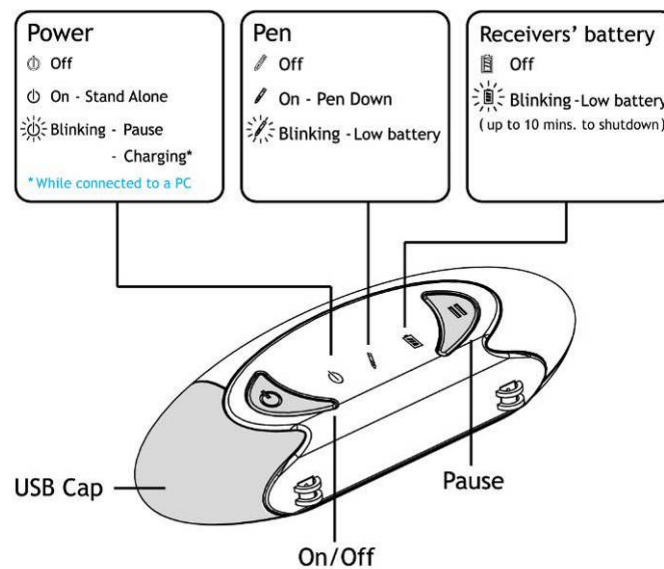
**NOTE:**

You must charge the receiver for 6 hours before using it for the first time. While charging, make sure the on/off led is blinking

Step 3: Clip the Receiver to a Sheet of Paper

The Receiver's default position is on the top middle of an A4 or letter-sized paper (or smaller) in portrait position. You can use any orientation (portrait or landscape).



NOTE:

If you want to position the clip in a different location on the page, you must modify the receiver's position in the Multiplatform Viewer application (Tools→Set receiver position) or in any other application

Attach the Receiver to a sheet of paper by pressing the white button (clip) on the underside of the Receiver, and then insert a sheet of paper, a notebook or a paper block.

Be sure to position the Receiver at the center of the chosen page edge (see following drawing).

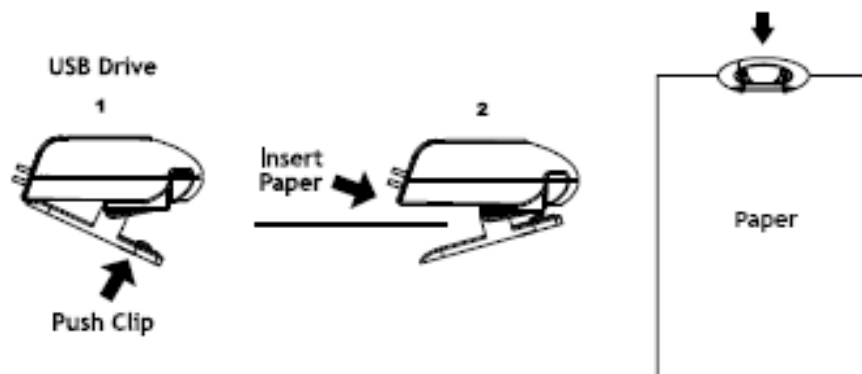

Step 4: Turn On the Receiver

To turn the Receiver on, press the **On/Off** button (the far left button on the Receiver's front panel). The left and right LEDs will light up. Wait until the power light turns red and stops blinking. This signals that the Receiver is now ready to work with the Zpen.

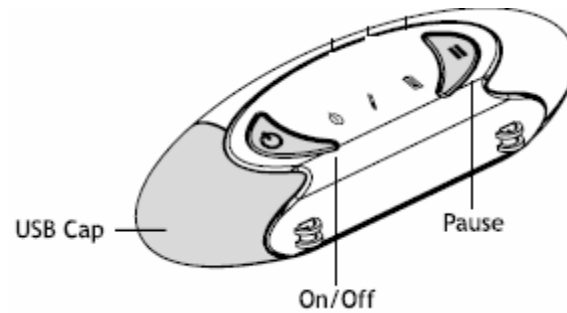

Step 5: Begin Writing

You are now ready to write anywhere! As you write, the data is stored in real time as files on the Receiver.



NOTE:

While writing, make sure the line of sight between the pen and the receiver remains clear.

In addition, keep your fingers away from the crystal cone at the bottom part of the pen (see drawings below)



Right way

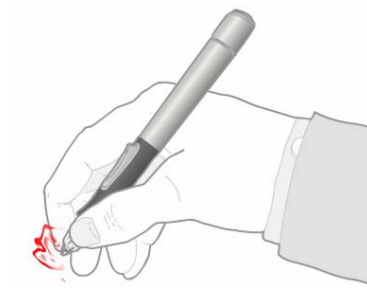

Wrong way

To add a new page, simply press the clip button and attach the Receiver to a new page. The software automatically adds a new virtual page to your document.

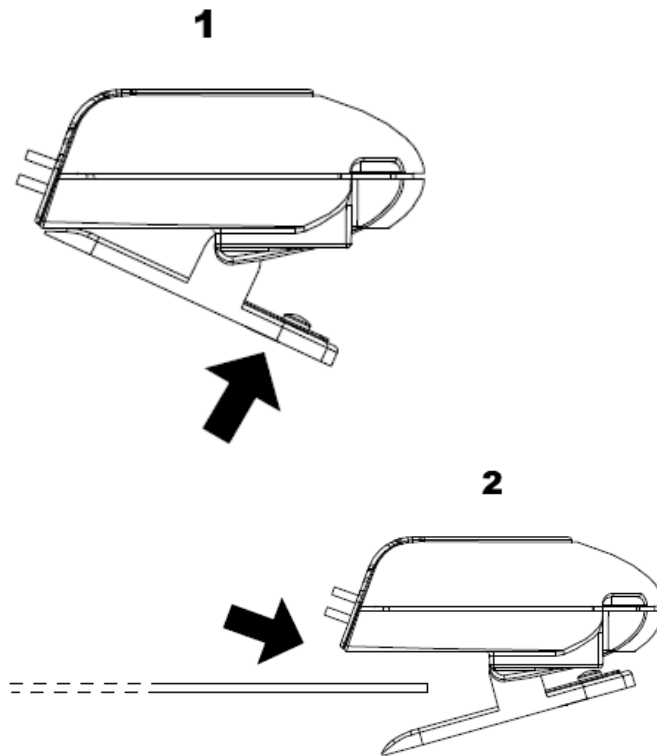

Continue writing until you complete your document. If you want to take a break during your writing, press the **Pause** button on the Receiver, which gives an additional 30 minutes before the receiver will shut itself down. This conserves the battery for longer use. When you resume writing (pen down), the receiver will exit Pause mode and the Power LED will stop blinking



TIP:

To draw straight lines, keep the pen at the same angle and move your hand. Be sure not to block the line of sight to the Receiver.

When you finish writing, press and hold the **On/Off** button on the Receiver until all LEDs stop blinking and turn off (around two seconds), and then remove the Receiver from the sheet of paper.

Step 6: View Your Files on the Computer

Several software applications are available for viewing, editing and text converting of your handwritten captured files; the Multiplatform Viewer is one of them.

The Multiplatform Viewer is an application that can be used without full software installation for simplified viewing capabilities.

The Viewer can be accessed either via a direct launch when plugging the receiver to the PC or via the PenInkViewer folder located on the flash drive itself.

A simple walk through usage of the Viewer is presented below.

Viewing Files Using Pen&Ink Viewer

Connect the Receiver to any free USB slot on a computer. The Receiver is automatically recognized as a mass storage device once it is connected, and displays the following window once the connection is established:

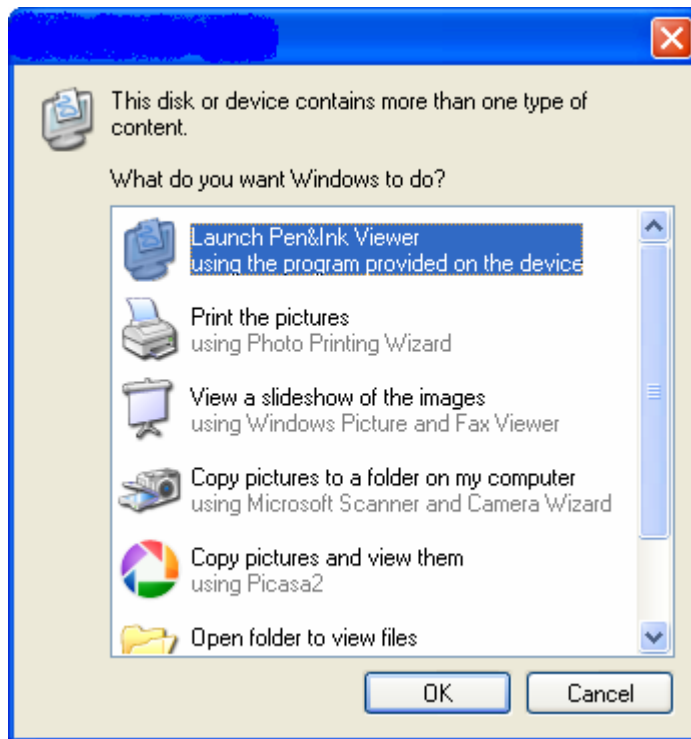

Select the **Launch Pen&Ink Viewer** option in the list and click **OK**. This action opens the Viewer application, in which you can view *.eli files.

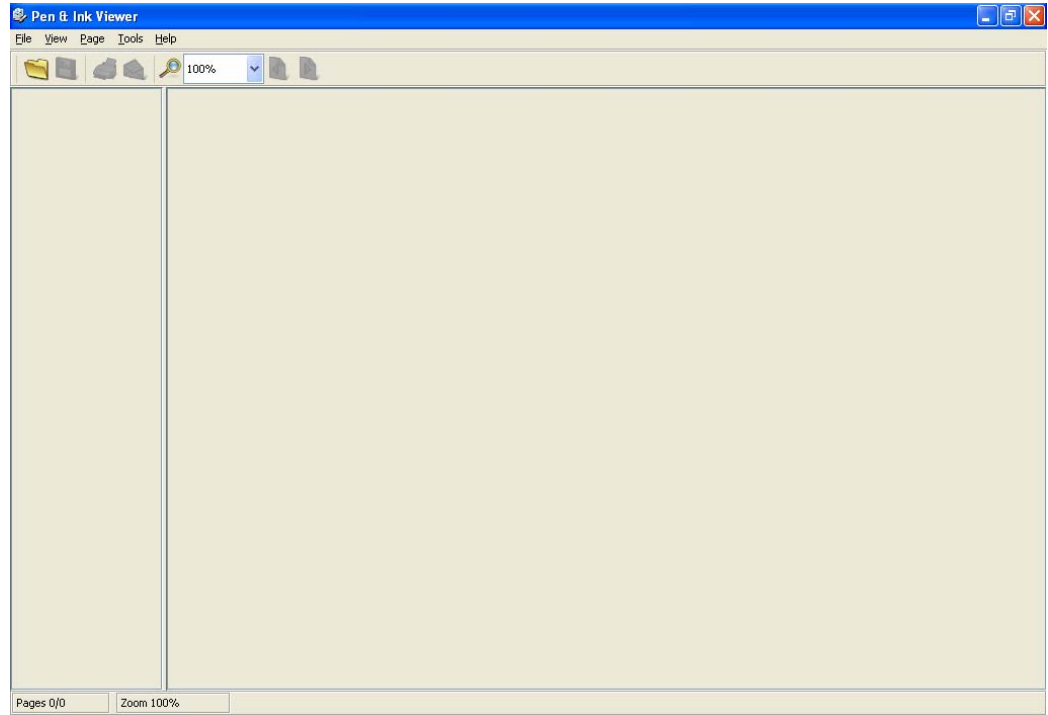

To open one of your files, click the **Open**  icon in the Pen&Ink Viewer main window and then navigate in the window that opens to the **My Notes** folder on the USB Flash Drive. Then, select the relevant file with a *.eli extension.

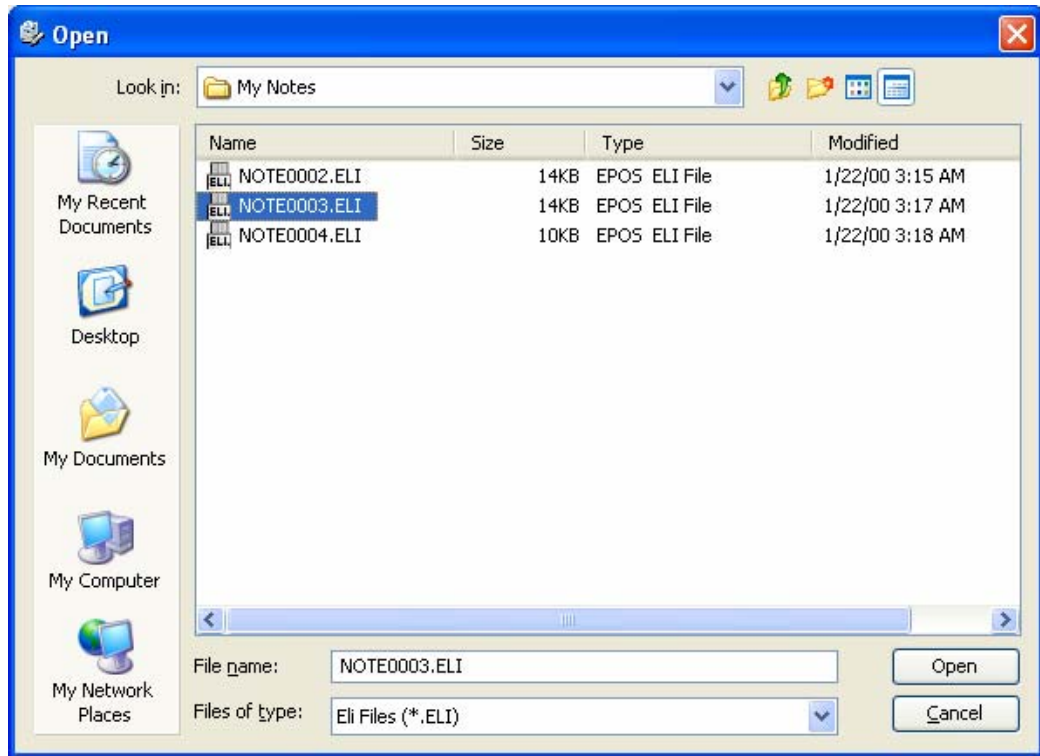

Your file is automatically displayed in the Pen&Ink Viewer main window.

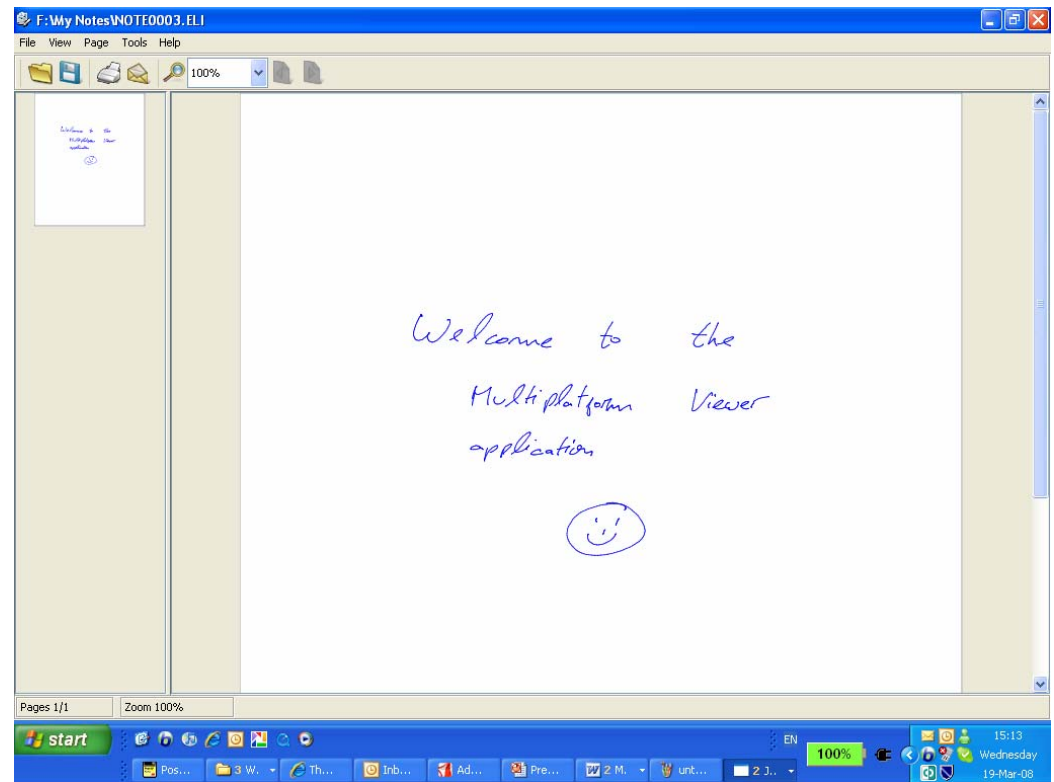

See *Chapter 3, Using the Multiplatform Viewer Application*, for more details about how to use this application.

Tips – Important Facts to Know

- ❖ Please make sure to charge the device for 6 hours before using for the first time. While charging, make sure the on/off LED is blinking
- ❖ Please take care NOT to dismantle the pen's crystal cone or receiver
- ❖ To add a New Virtual Page, press the receiver's clip button (at least 0.5 seconds). The pen LED indicator (middle light on the receiver) will turn on for 0.5 seconds, indicating the creation of a New Virtual Page
- ❖ The receiver will turn itself off automatically after being idle for 10 minutes
- ❖ When the receiver battery LED (far right LED) starts blinking, one has up to 10 working minutes until the receiver will shut down. Only after charging the receiver, will you be able to turn it on again
- ❖ Make sure the receiver is centralized on one of the paper's edges
- ❖ The RESET button (small hole in the back of the receiver) should be pressed in the following cases:
 - Whenever the receiver is stuck (all LEDs are constantly on or blinking)
 - When the receiver is charged, the receiver turns off after turning it on, or alternatively, the receiver doesn't turn on at all.

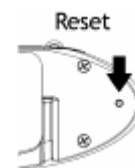

- ❖ The Pause button extends the automatic turn-off of the receiver to 30 minutes (the Power LED will start blinking when entering power saving mode). When you resume writing (pen down), the receiver will exit Pause mode and the Power LED will stop blinking
- ❖ Low Quality Zone – Directly in front of the receiver, there is a one inch (2.5 cm) area that may result in lower handwriting capture quality. For best results, begin writing further than one inch (2.5cm) away from the front of the receiver



- ❖ Avoid writing on uneven surfaces
- ❖ If you want to set the date and time of your files, open the Viewer application and go to Tools > Set Clock

Chapter 3

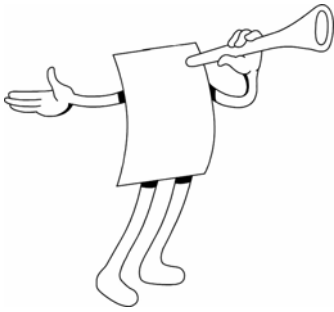

Using the Multiplatform Viewer Application



About this chapter

This chapter describes how to use the Zpen with the Multiplatform Viewer application. The Viewer software is stored on the Receiver, and provides simple viewing capabilities, without the need to install any special software.

The Multiplatform Viewer application is suitable for Windows users as well as MAC OS X and several Linux OS'

The Multiplatform Viewer application is ideal for students, as it enables you to take notes during class using the Zpen and Receiver, and then plug in the Receiver to a USB port on any computer to view your files, such as at the library. All required software is already installed on the Receiver.

This chapter contains the following sections:

- **Multiplatform Viewer Main Window**, describes the application's main window and its components.

- **Navigating**, describes the several navigation methods used to maneuver within the Viewer application.
- **Saving**, describes the multiple options available for saving Viewer information.
- **Printing**, describes how to print the current document.
- **Emailing**, describes the multiple options available for emailing Viewer information.

Multiplatform Viewer Main Window

The Multiplatform Viewer main window, shown below, is comprised of several areas, including the:

- **Menu bar**
- **Toolbars**
- **Pages pane**
- **Writing area**

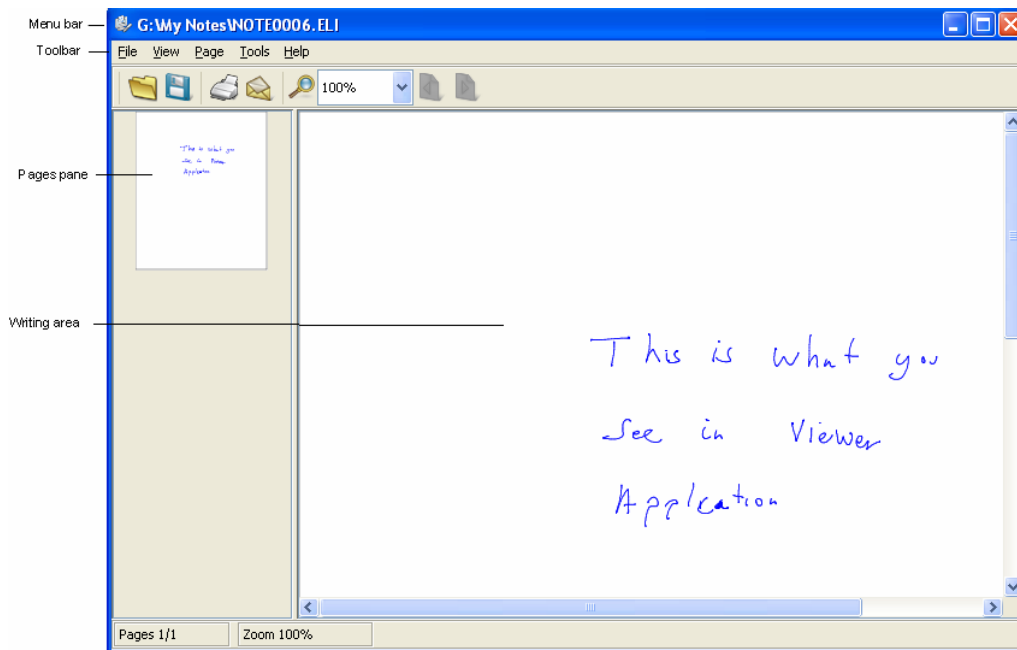

Menu Bar

The main menu provides easy access to Multiplatform Viewer application functionality.



TIP:

Most application options are accessible from both the menu bar and the toolbars. See the *Toolbars* section for more details about available application options.

The following menu options are available:

File

File	View	Page	Tools	Help
Open				Ctrl+O
Close File				
Save As PDF				Ctrl+S
Email As PDF				Ctrl+E
Print				Ctrl+P
1. G:\My Notes\NOTE0006.ELI				
Exit				

The *File* menu has the following options:

- **Open:** Opens a *.eli document
- **Close File:** Closes the document currently open
- **Save As PDF:** Saves the current document as a PDF file
- **Email as PDF:** Emails the current document as PDF file
- **Print:** Prints the current document
- **Recent Files:** Shows a list of the five most recent files opened in the application
- **Exit:** Closes the application

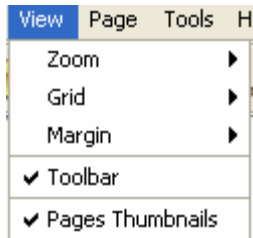
Zpen User's Guide**View**

The *View* menu has the following options:

- **Zoom:** Resizes the view to the specified percentage
- **Grid:** Adds grid lines to the document
- **Margin:** Adds a margin guide to the document
- **Toolbars:** Enables you to show/hide the application's three toolbars
- **Pages Thumbnails:** Toggles to show/hide thumbnails in the Pages pane

Page



The *Page* menu has the following options:

- **Previous Page:** Moves to the previous page
- **Next Page:** Moves to the next page
- **Save Page As:** Saves the current page as graphical file-GIF, PNG, BMP or JPEG image

Tools

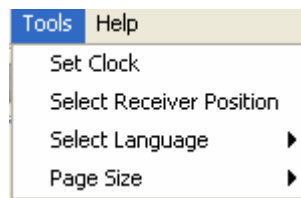

The *Tools* menu has the following option:

- **Set Clock -** Sets Clock and Date to the local time
- **Select Receiver Position -** Selects desired receiver position on the page
- **Select Language:** Selects the Viewer language to the desired language
- **Page Size:** Selects page size, A4 is default size

Help



The *Help* menu has the following option:

- **About:** Displays version information about the Pen&Ink Viewer application

Toolbars

The Multiplatform Viewer application contains several toolbars for quick access to application functionality.

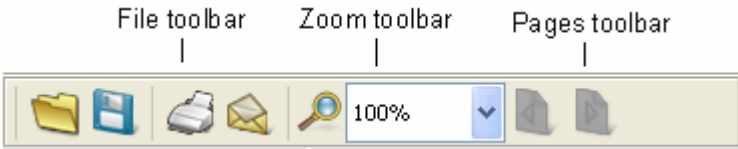

TIP: Most application options are accessible from both the menu bar and the toolbars.

Toolbars include the:

- **File** toolbar
- **Pages** toolbar
- **Zoom** toolbar



NOTE: You can hide/show the toolbar by selecting View → Toolbar



File Toolbar

The **File** toolbar contains the following icons:

Icon	Name	Shortcut	Function
	Open	Ctrl+O	Opens a file.
	Print	Ctrl+P	Prints the file.
	E-mail as PDF	Ctrl+M	Emails the document through your default email program, as PDF file

Pages Toolbar

The **Pages** toolbar contains the following icons:

Icon	Name	Shortcut	Function
	Previous Page	Page Up	Moves to the previous page
	Next Page	Page Down	Moves to the next page

Zoom Toolbar

The **Zoom** toolbar contains the following icons:

Icon	Name	Shortcut	Function
	Zoom		Specifies the zoom percentage.

Pages Pane

The left side of the Multiplatform Viewer main window contains a Pages pane. This area is used to manage the pages in the file and to display thumbnail for each page.

Writing Area

The Writing Area displays the contents of your written page.

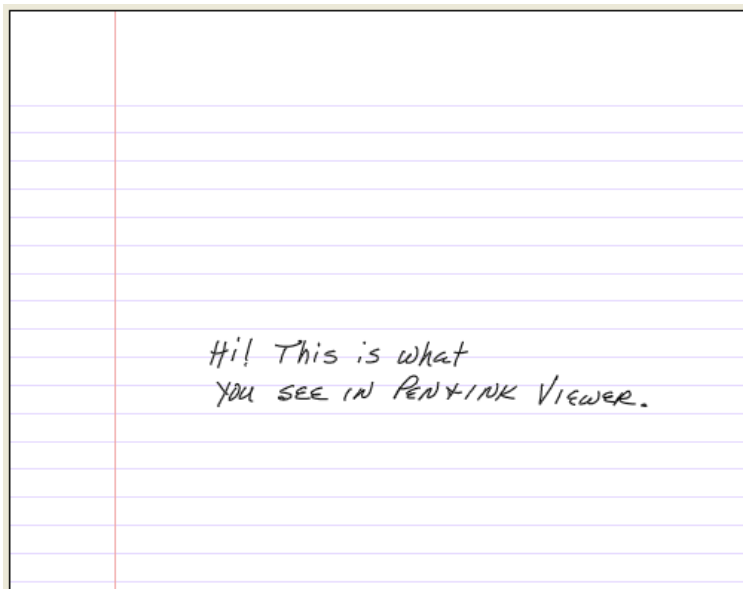
Zpen User's Guide

You can add or remove grid lines and a margin guide to this area to meet your personal needs.

Margins and Grids

Like a physical sheet of paper, you can set up the Multiplatform Viewer page to have both grids (or lines) and margins.

➤ **To set up the page grid:**

In the menu bar, select **View** ➔ **Grid**.

Select the required grid setting. You can select from the following options:

- **None** (the default). No grid lines are displayed.
- **Legal:** Displays only a horizontal grid on the page.



- **5 x 5:** Displays both a horizontal and vertical grid on the page.

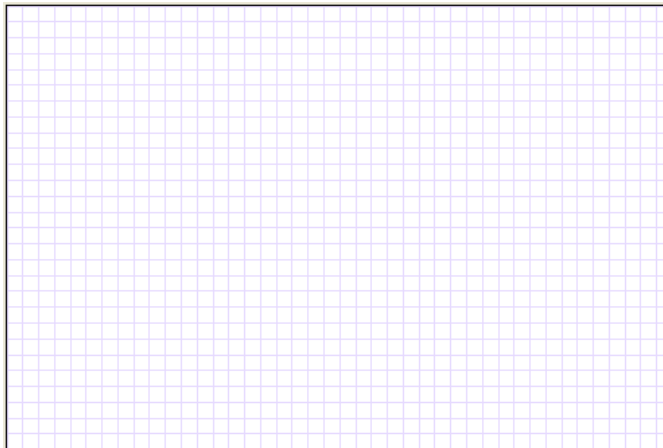

➤ **To set up a page margin:**

In the menu bar, select **View** ➔ **Margin**.

Select the required margin setting. You can select from the following options:

- **None** (the default): No margin guide is displayed.
- **Left**: Displays a margin guide on the left margin of the page.

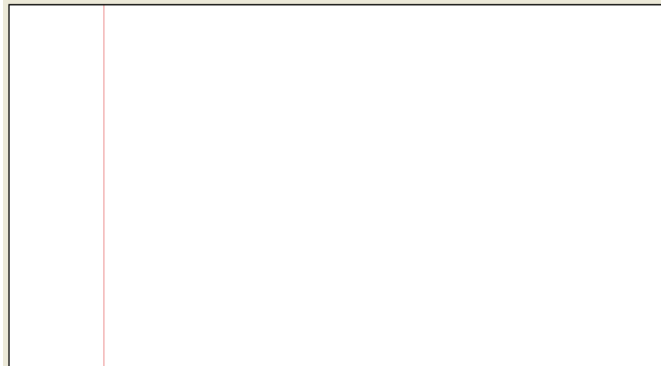

- **Right**: Displays a margin guide on the right margin of the page.

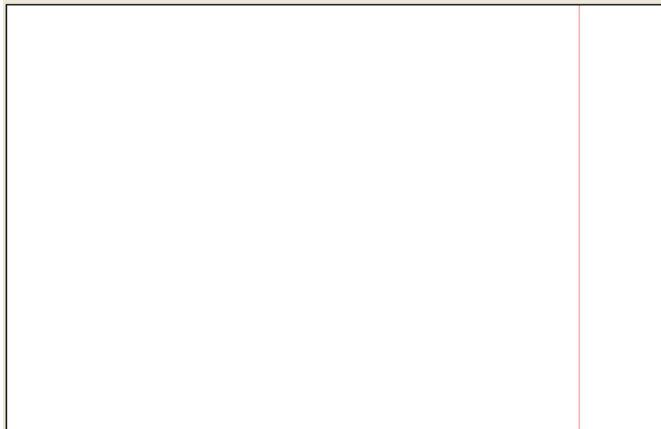

Navigating



There are several levels of navigation within Multiplatform Viewer:

- Within the document
- Between documents

Each of these levels is described in the sections that follow.

Moving from Page to Page within a Document

There are two ways to jump from one page to another within a document:

- **Previous Page**  and **Next Page**  buttons: Use these buttons in the toolbar to jump to the previous and next pages in the document, respectively.
- **Thumbnails in Pages pane:** The Pages pane contains a thumbnail for each page in the document. Simply click a thumbnail to jump to the corresponding page in the document.

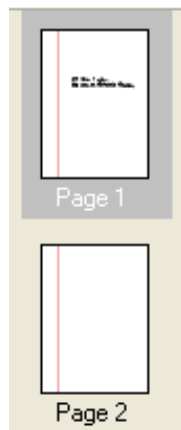

Zpen User's Guide

Opening a Document

When you open Multiplatform Viewer, the application opens displaying an empty main window. You must open a document within the application to view its contents.

➤ **To open a document:**

Click the **Open**  button in the toolbar or select **File** ➔ **Open** in the menu bar. The *Open* window opens:

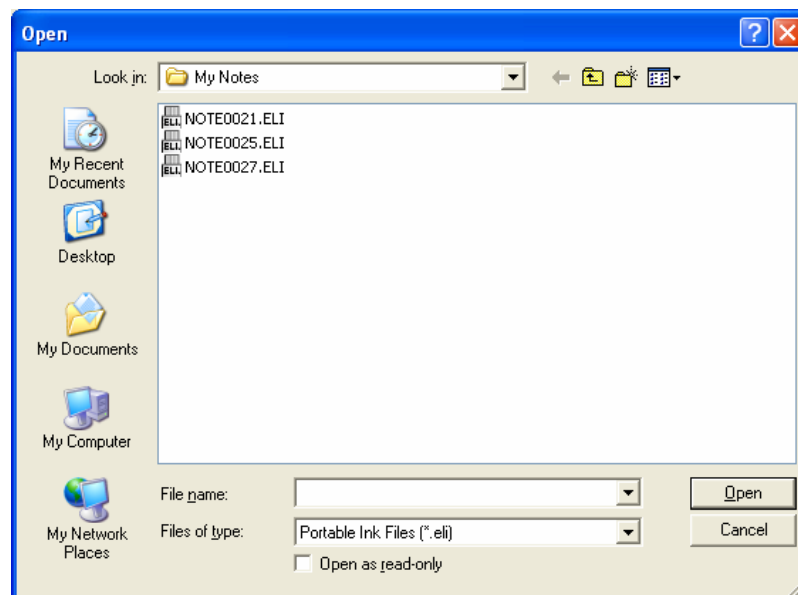

Browse to select the file you want to open and click **Open**. The document you selected now appears in the Writing Area in the window.

Saving

You can save Multiplatform Viewer documents using the following methods:

- **Save Current Page To Picture:** This option only saves the current page as an image file (either JPEG, BMP, GIF or PNG). If you have a multi-page document and you want to save each page as a picture, you must repeat the relevant procedure for each page.
- **To save the document as a PDF file:**
 - In the menu bar, select **File** → **Save As PDF**. In the window that opens, specify a filename and location for the file and click **Save**.
- **To save the current page as a picture:**

In the menu bar, select **Page** → **Save Page As**. The *Save Page As* window opens:

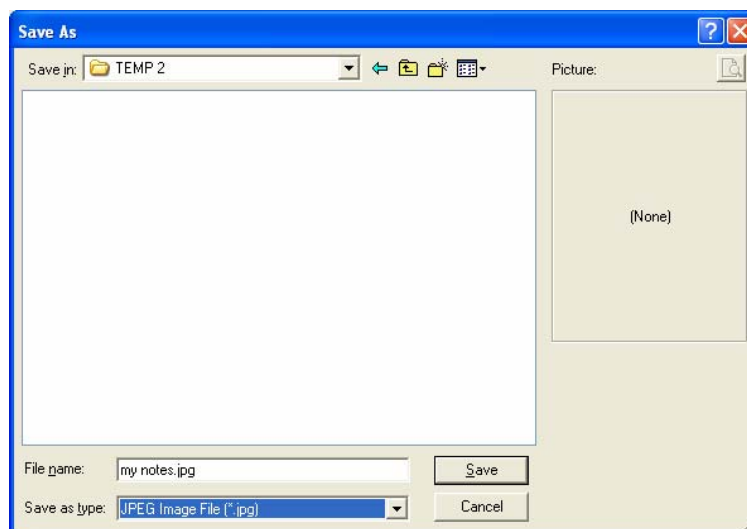

In the **File name** field, enter a name for the picture.

In the **Save as File type** field, select the file type for the file. You can select one of the following options:

- **JPEG Image File:** Saves the file as a JPEG image (*.jpeg).
- **PNG Image File:** Saves the file as a PNG image (*.png).
- **GIF Image File:** Saves the file as a GIF image (*.gif).
- **BMP Image File:** Saves the file as a bitmap image (*.bmp).

Click **Save**.

Printing

You can print a hard copy of a Multiplatform Viewer file when needed.

➤ **To print a file:**

Click the **Print**  button in the toolbar or select **File** ➔ **Print** in the menu bar. The *Print* window opens.

Set up the print job as needed and click **OK**.

Emailing

Multiplatform Viewer simplifies the process of emailing a document by automatically attaching it to an email message as a PDF file. Emailed documents are always sent in PDF format.

You can email Pen&Ink Viewer documents using the following method:

- **Email as PDF:** Emailing in this manner emails the entire document as PDF file.

➤ **To email an entire document:**

Click the **E-mail**  button in the toolbar or select **File** ➔ **Email As PDF** in the menu bar. This automatically opens an email window from your default email program.

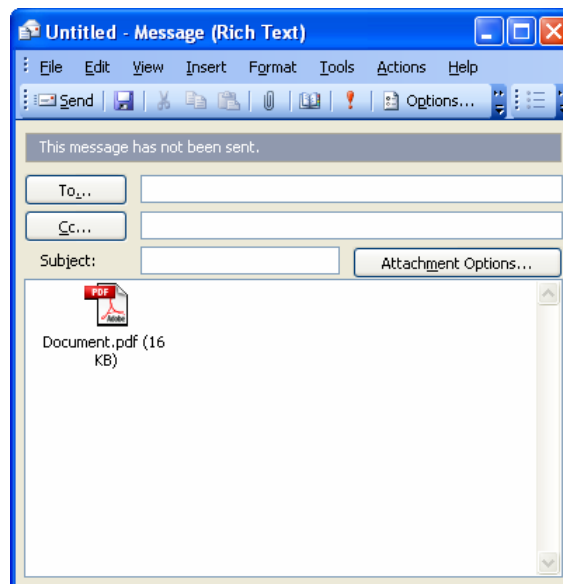

Select or enter the intended recipients. You can add a subject and message as you would when sending a regular email message.

Click **Send**. Your email program automatically sends the message.

Set Clock

Multiplatform Viewer enables the user to set the local time and date. The written files in the receiver will be saved with the local date and time when file was created.

In the menu bar, select **Tools** ➔ **Set Clock**

1. Select the drive on your computer where the receiver is located
2. Set the desired date and time and press the set clock button.
3. Disconnect the receiver from the computer, wait for the power LED to stop blinking and turn the receiver off.
4. Press OK to complete the process

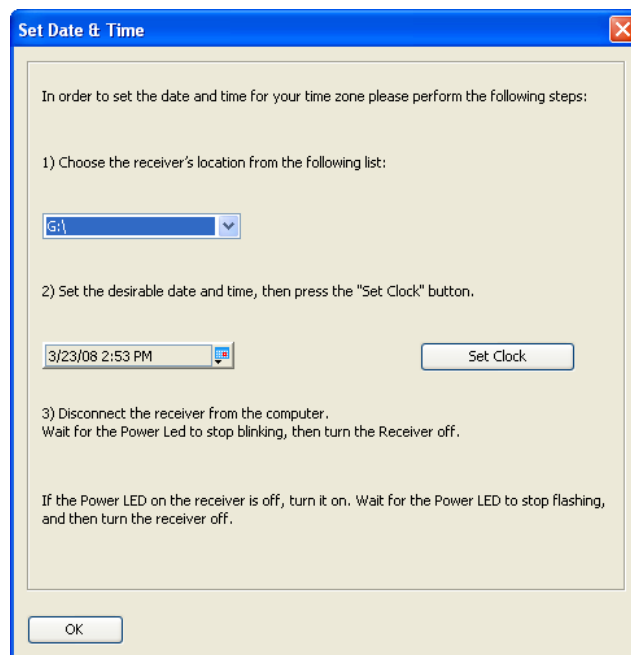

Select Receiver Position

Multiplatform Viewer enables the user to set the receiver on the preferred location, such as top of page, right, left and bottom of page, with the default location being the top of the page.

Regardless of preferred receiver positioning, user must keep a clear line of sight between Zpen and receiver.

In the menu bar, select **Tools** → **Select Receiver Position**

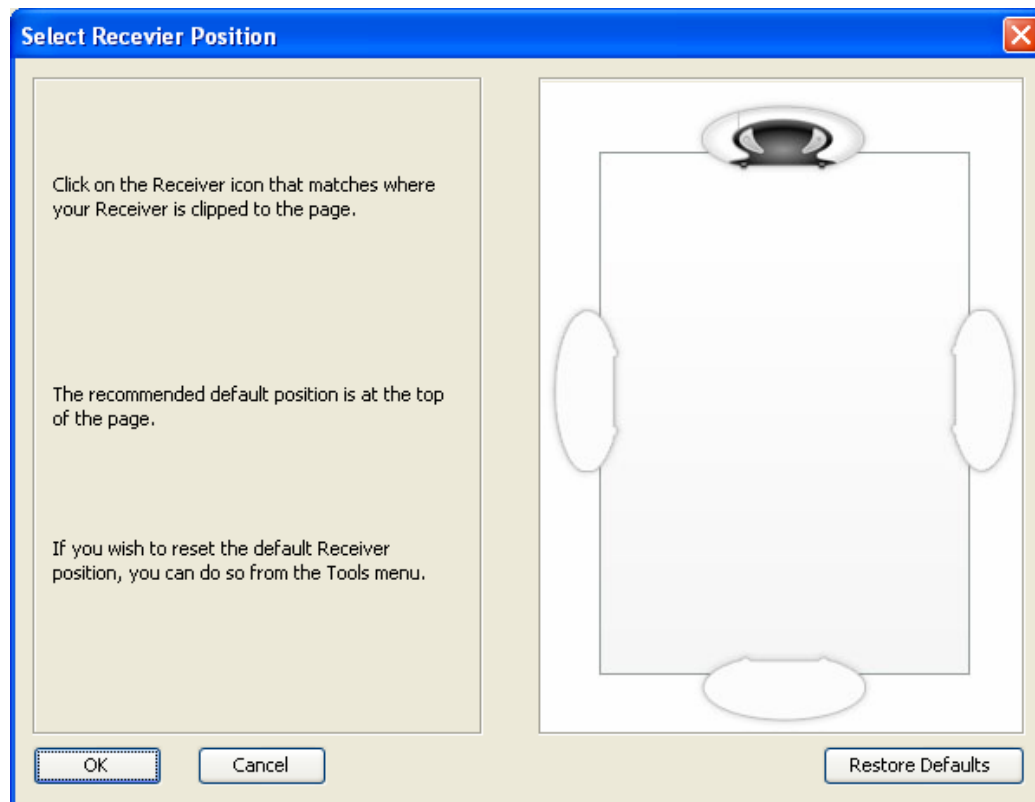



Appendix A

FAQ

Overview

This section consists of questions and their respective detailed answers, addressing the following topics:

- a. General product-related issues
- b. Getting started (installation and first use of the product)
- c. Receiver
- d. Zpen
- e. Multi-platform Viewer

General

- Can I use the Zpen on any surface? Can I take notes on my lap?
 - o A: Yes. As long as the writing is done on a relatively smooth surface and a clear line-of-sight is maintained between the pen and receiver
- Does the product work in a noisy environment?
 - o A: Generally speaking, yes, it does; Zpen technology knows how to ignore out-of-band noises (generated below 25Khz and above 80Khz) and implements “smart” algorithms to deal with in-band noises (25-80Khz).
- Can two or more people use a Zpen next to each other at the same time?

- A: Yes. The current version allows two or more users to sit next to each other and work without worrying for interferences
- Is it compatible with MAC and Linux operating systems?
 - A: All digital files captured by the Zpen's receiver can be viewed in MAC OS X and several Linux operating systems using the Multiplatform Viewer stored on the receiver itself

Getting started

- The PC does not recognize the receiver after plugging it in.
 - A: Change the USB port and USB cable and try again. If it still does not recognize the receiver, restart the receiver by pressing the Reset button on the back of the receiver (small hole near one of the edges).
- The receiver's error LED (right most LED) blinks when operating the device for the first time.
 - A: The receiver's battery arrives uncharged. Charge the device for 6 hours (the power LED should blink while charging) before first use.
- How do I use the receiver when writing on a thick pad of paper?
 - A: Clip the receiver to the side of one of the pages (or to the bottom, as long as you maintain a clear line-of-sight) and start writing.

Receiver

- How many digital pages can the receiver store?
 - A: Several thousand pages (an average page size is approximately 300KB).
- How do I know when to charge the receiver?
 - A: When the receiver's battery LED (right most one) starts blinking, this signals that the receiver battery is running low and should be recharged (in this case you will have several more minutes before the receiver shuts itself down automatically).
- When plugging the receiver in to my computer, I do not see the power LED blinking; what's wrong?

Zpen User's Guide

- A: The receiver is not being charged; the computer may not be providing enough current to charge the receiver. Therefore, replace the USB port (or the USB extension cable) on your computer or try to recharge it on a different computer.
- Part of the text I wrote was not saved.
 - A: The receiver turned off due to a low battery level. Recharge the battery.
- How long do I need to charge the receiver's battery?
 - A: Recharging an empty battery until it is full may take 5-6 hours.
- How do I know when the receiver has finished charging?
 - A: While charging, the power on LED (left most LED) blinks. When it stops blinking (turned on), the receiver is fully charged.
- Is there an indication for "flash memory full"?
 - A: The right most LED starts blinking rapidly.
- Do I need to replace the receiver's battery?
 - A: No. The receiver's battery is a rechargeable and capable of running hundreds of charging cycles.
- How do I know that I turned a page on the receiver?
 - A: Upon releasing the receiver's clip, you will notice the pen LED (middle LED) turning on for 0.5 seconds, indicating that a new page has been opened.
- Can I plug in the receiver into the computer without turning it off first?
 - A: Yes; however we recommend turning it off first.
- All lights are on, and the receiver does not respond.
 - A: This might happen due to problems in the USB power or with the connector's contacts. Restart the receiver by pressing the reset button on the back (small hole near one of the edges).

Pen

- How do I know that the pen is transmitting?
 - A: When you start writing, the pen down LED (middle one) turns on every time the pen tip touches the writing surface.
- When writing, the pen down LED (middle LED) does not turn on.

- A: Several factors might affect the reception of the pen's transmission: (i) there must be a clear line-of-sight between the pen and receiver. (ii) also, look to see how you write; do not block the crystal cone (the transmission component) at the bottom part of the pen. (iii) low pen batteries.
- What is the indication for "*pen batteries running low*"?
 - A: The pen LED (middle one) starts blinking rapidly.
- How do I replace the Zpen's batteries?
 - A: Refer to the relevant section in the User Guide.
- What type of batteries should be used with the Zpen?
 - A: The common batteries are standard 393 (watch) ones.
- What type of ink refill is used with the Zpen?
 - A: Standard mini-ballpoint refill.
- How do I change the ink refill?
 - A: Simply pull the pen tip out of the Zpen and insert the replacement pen refill into the Zpen

Multiplatform Viewer

- How do I set the date and time of my created files?
 - A: open the Multi-platform Viewer application and go to Tools→Set Clock



Appendix B

Troubleshooting guide

TYPE	PROBLEM DESCRIPTION	WORKAROUND
Getting started	The PC does not recognize the receiver after plugging it in	i) Change USB port and retry ii) Restart the receiver by pressing the reset button (back of the receiver)
	Receiver's error LED (right most LED) is blinking	Recharge the receiver for the first time (about 6 hours)
Receiver	Receiver's error LED (right most LED) is blinking	i) Low battery – recharge the receiver ii) The receiver's memory is full
	After plugging in the receiver to the computer, the power LED is off (and not blinking, as it should be)	Replace the USB port on your computer or try to recharge it on a different computer
	All lights are on and the receiver does not respond	Restart the receiver by pressing the reset button (back of the receiver)
	Receiver turns off immediately after turning it on	Charge the receiver for at least one hour and try again; if the problem persists, press the reset button (back of the receiver)
	Receiver does not turn on	Charge the receiver for at least one hour and try again; if the problem persists, press the reset button (back of the receiver)
Pen	When writing, pen down LED (middle LED) does not turn on	i) Clear line-of-sight between the pen and receiver ii) Do not block the crystal cone iii) Replace pen batteries
	Pen LED (middle one) starts blinking rapidly	Pen batteries are running low



Appendix C

LED Functionality Index

FUNCTIONALITY	LED OPERATION	DESCRIPTION
Normal Operation	Power Pen Receiver ○ ○ ○	Off
	Power Pen Receiver ● ○ ○	On
	Power Pen Receiver ● ● ○	On – Pen down
	Power Pen Receiver ● ● ○	On – New Page indication (after pressing the clip for at least 0.5 second)
Charging	Power Pen Receiver ⊙ ○ ○	Charging
	Power Pen Receiver ● ○ ○	Finished charging
	Power Pen Receiver ○ ○ ○	No charging – Computer does not provide enough current to charge the receiver
Receiver errors	Power Pen Receiver ● ○ ⊙	1) Low receiver battery – charge it 2) Flash memory full
	Power Pen Receiver ● ● ●	Receiver stuck (rarely) – restart the receiver
Pen error	Power Pen Receiver ● ⊙ ○	Low pen batteries – replace them